

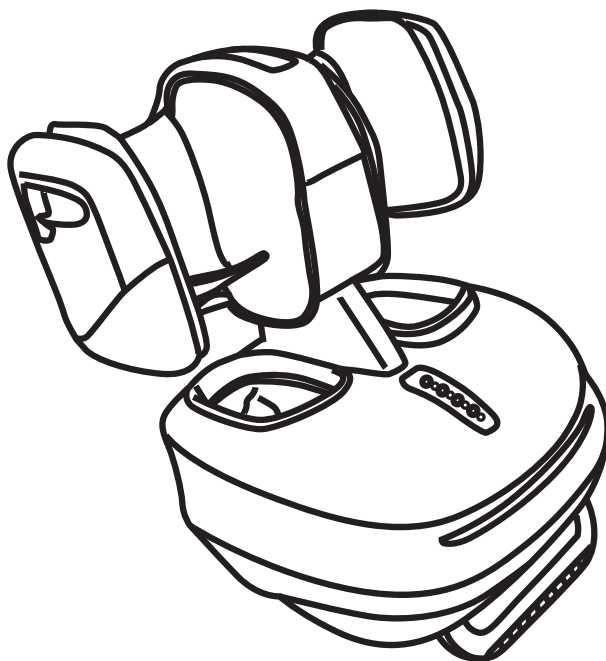

Omknee

total foot reflexology **2.0**



User Manual
OF2004 使用手册





OGAWA

Omknee

total foot reflexology **2.0**

User Manual



All information is correct at the time of print





CONTENTS

| | |
|--|----|
| Safety Instructions | 03 |
| Warranty Claims | 06 |
| Product Parts | 07 |
| Product Features And Operation Illustrations | 08 |
| Product Operation Guide | 09 |
| Product Maintenance | 13 |
| Troubleshooting | 14 |
| Product Specifications | 15 |
| Contact Us | 16 |



Thank you for purchasing OGAWA OmKnee **2.0** leg massager. Please read the Safety Precautions carefully before using the leg massager. The Safety Precautions are divided into 'warnings' and 'attention' in terms of the degree of danger. This book should be kept available for future reference after reading.



Safety Instructions

a) Important safety instructions

- To ensure a safe and proper operation, please read the instruction manual carefully before using this product.
- Use this product only as described in this manual.
- Always unplug this product from the electrical outlet immediately before cleaning.
- Do not use this product if you have sensitive skin, neuropathy
Don't let children or people with mental disabilities use the heating function without proper supervision. Improper use may be dangerous.
- Do not operate this product under a blanket or when covered. Over-heating can occur and cause fire, electric shock or injury.
- Do not cover this product in order to avoid electrical faults or damages due to excessively high motor temperature.
- Stop the massage immediately if you feel any discomfort.
- Never operate this product if it has been dropped, has a damaged cord or plug; experiences a malfunction, or if it has been dropped in water. Please contact an authorized service centre to do the necessary check and repair.
- Do not use the components that are not recommended by OGAWA.
- Do not insert any objects into any openings in the product.
- If you want to cut off the power supply, please make sure you have turned off all the operating controls, as well as remove the power plug from the socket.
- Please do not use this product as a medical device. If you need a professional diagnosis or treatment, please consult a professional medical person.

b) Operating Environment Precautions

- Do not use this massager in humid or extremely dusty environments to avoid malfunction.
- Do not use this massager at a temperature above 40 degree centigrade.
- Do not use this massager outdoors.
- Avoid placing or operating this massager in direct sunlight or near a heating appliance, stove.



Safety Instructions

c) User precautions

- Make sure that this product is far away from any hot surfaces.
- Please consult your doctor before use for those who have the following diseases:
 - Those who have heart disease, malignant tumor, spinal scoliosis, osteoporosis, etc.
 - Those who are pregnant or having a menstrual period.
 - Those who have a physical discomfort, fever, a swelling or inflammation, bruises, allergies, etc.
 - Those who are warned by the doctor not to do any massage to avoid injury or physical discomforts such as blood clots (thrombosis), severe aneurysm, acute venous tumor, all kinds of skin inflammation, infectious skin disease (including subcutaneous tissue inflammation), etc.
 - Warnings: Do not use the massager together with the following medical instruments.
 - 1) Those who are using a pacemaker or other implantable medical equipment.
 - 2) Those who are using an artificial heart.
 - 3) Those who are wearing an electrocardiograph for similar medical equipment.

Otherwise it will cause malfunction for those medical equipment, putting the user's life in danger.

d) Precautions for power supply

- Do not turn on the switch when your hands are wet.
- Do not immerse in or spray water or liquid on the control power switch.

e) Cord/Plug Precautions



- Do not connect or remove the plug with wet hands. Otherwise you will suffer an electric shock or a product malfunction.
- Do not pull the wires when you pull out the power plug. Please hold the plug itself.
- As the default operating time is 15 minutes, all the functions will stop working after 15 minutes. Turn off the main ON/OFF switch when not in use
- Keep the cord away from hot surfaces.
- Do not place the power plug under the product or any heavy items.



Safety Instructions



- Do not wind the power plug around the product lest it should be damaged and cause an electric shock or fire.
- Do not operate this product if it has a damaged cord or plug.
- Do not use this product if the power socket is loose.
- Do not carry this product by its supply cord or use the cord as a handle.
- When the power plug is damaged, please call the service centre or an authorized technical person for the necessary check and maintenance.

Attention

- 
- 
- Do not fall asleep during massage.
 - Do not use this product while you are drunk or physically uncomfortable.
 - Don't stand on the product or put a heavy weight on it.
 - Do not use this product for more than 30 minutes.
 - Do not use this product if the cloth cover is worn out.
 - Do not use this product within an hour before or after a meal.
 - When you are using the product at a low room temperature, do not suddenly use the heat function. You can adjust the room temperature to normal room temperature, before starting the heat function.
 - When moving this product from a low temperature storage place to a warmer setting, it may cause malfunction due to water vapor gathered in the components. Set the product in a normal room temperature for one hour before using it.
 - Do not use this product if you find any components damaged or the product in an abnormal condition.
 - When current interruption occurs during your massage, try to avoid further damage due to sudden power restoration.
 - Stop using the product if there is thunder and lightning.



Warranty Claims

1. Warranty does not cover accessories and upholstery.
 2. Warranty is not transferable.
 3. This warranty is effective only if the product is purchased from OGAWA.
 4. Proof of purchase (original receipt) is required for all warranty repairs.
 5. All implied warranties, including but not limited to these implied warranties of fitness and merchantability, are limited to the duration stated in the warranty policy.
 6. Damage due to misuse, improper treatment and unauthorized modification and repair are not covered by this warranty.
 7. Warranty does not cover accessories and attachments which do not belong to the massage unit.
 8. Warranty is not effective to rental, business, commercial, institutional or other non-residential users.
 9. All services covered by this warranty must be approved by OGAWA and repaired by authorized technicians only.
 10. If replacement parts for defective materials are not available, OGAWA reserves the right to make substitution in lieu of repair or replacement.
- 
- 

The instructions state that

1. the appliance is not to be used by persons (including children) with reduced physical, sensory or mental capabilities, or lack of experience and knowledge, unless they have been given supervision or instruction
2. children being supervised not to play with the appliance

Product Parts

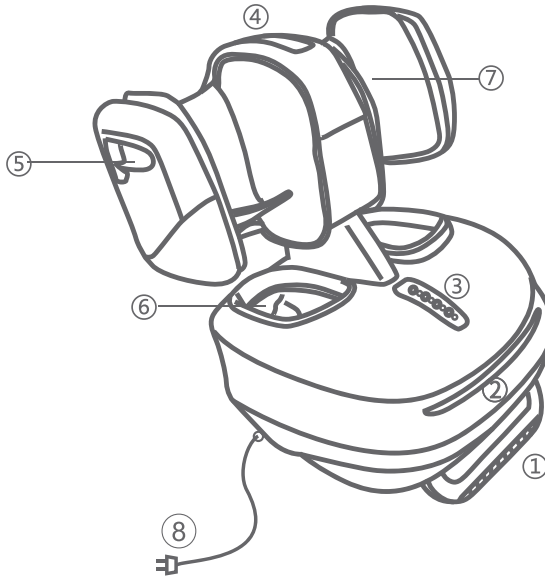

- ① Stand
- ② Decorative plate
- ③ Controller button (Lower)
- ④ Controller button (Upper)
- ⑤ Detach button
- ⑥ Detachable fabric cover
- ⑦ Fabric cover
- ⑧ Power Cord



Product operation illustrations

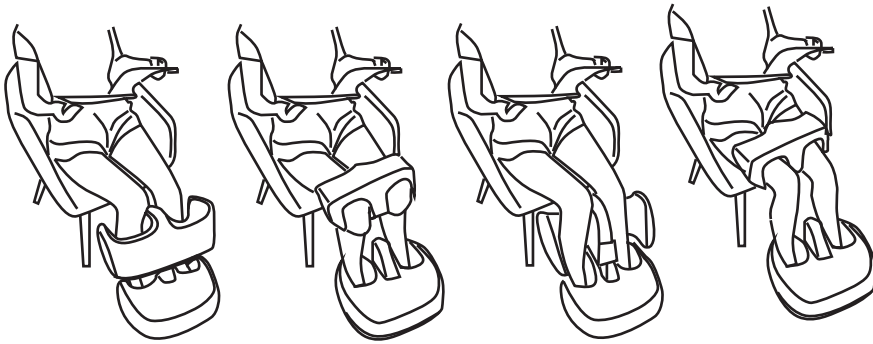

Remarks: If you would like to adjust a different angle in the process of massage, please make sure you have first turned off all the functions, before moving out your legs and then doing the necessary adjustment.

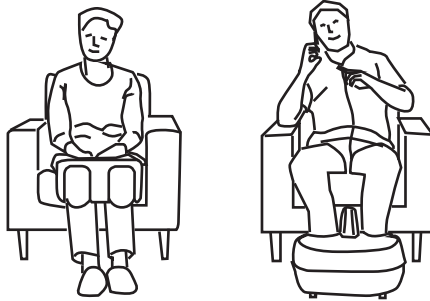

Product Operation Guide

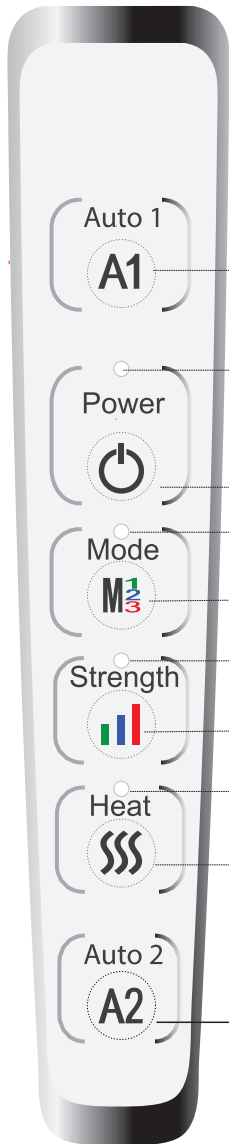

The upper operation panel can control the whole machine when both sections are conjoined, the bottom operation panel is not operable. Both operation panel can be used independently when the upper section and the bottom section are separated.

Press 'Auto' after press 'Power', green light is on, leg massage model starts, when conjoined, both sections work together, when separated, only leg function is activated..

Red light is on when the power is less than 50%, green light is on when the power is higher than 50%, red light flashes slowly when charging. After fully charged (over 90%), press 'power', green light is on, standby. It turns to energy saving mode if not any key operation in 10mins. Press again to turn off. (In any functional case, press 'Power' to energy saving mode).

After starting up, press mode. Mode light is on, green light is on mode 1, blue light is on mode 2, and red light is on mode 3.

After opening the mode, the Strength light is on, the green light is weak intensity, the blue light is medium intensity, and the red light is high intensity. program. This button is valid only when the mode is activated.

After starting up, press 'heat', red light is on, start heating. Press again to turn off. Turn on any Mode, and heat will start. (press 'Heat' to turn off).

After press 'Power', press 'Quick', blue light is on, knee massage model starts, when conjoined, both sections work together, when separated, only leg function is activated..

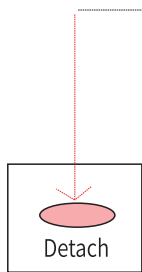

Detach button:

(The handle on the both side of the above section is provided with a separation key, which can be operated by pressing either key)

1. It can only be used when in standby mode, after all functions are shut down.
2. Press this key when both parts are conjoined, long press (within 6 seconds) 'Detach' to separate both , it will keep seperated while keep pressing 'Detach' .
- 3:when press 'Detach' to seperate, both section enters the 'standby' state, press any key to control. Press 'Detach' again when both parts are seperated (not need to press 'Power' first), leg massage mode 1 starts (red light is on),
- 4: when connect the upper to the base part, the indicator lights of the base part turn off, press the upper keys to control the machine.

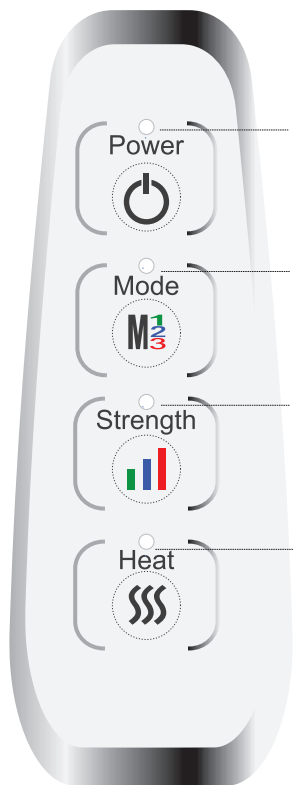

The lower keyboard panel can only be used when seperated.

Press 'Power' to starting up, red light is on. Press again to turn off. (In any function case, press Power' to turn off.)

After starting up, press mode. Mode light is on, green light is on mode 1, blue light is on mode 2, and red light is on mode 3.

After opening the mode, the Strength light is on, the green light is weak intensity, the blue light is medium intensity, and the red light is high intensity. program.This button is valid only when the mode is activated.

After starting up, press 'Heat', red light is on, starts heating. Press again to turn off. Turn on any mode and the heating will follow.(press 'Heat' can turn off).

Operation cautions

- 1.When in conjoined, the lower section is in the energized state, the power lamp in the upper section is green.
- 2.When in conjoined, the lower section unconnected to power, when the battery level is higher than the set value, the power lamp green light flashes,; while less than the set value, red light flashes, indicates it needs to be charging.
- 3.While in seperated, the upper section is power on, when the battery level is higher than the set value, the power lamp green light is on; while less than the set value, red light is on.
- 4.When in seperated, if the upper section is out of power, the lights will not on, please connect to the lower section to charge.



Product Operation Guide

a) Fasten instructions:

When both part conjoined, please do the follow step to check if they are well connected:

- 1:when connected, the upper sense light turns to green, and you will hear a prompt tone.
- 2:When the upper and lower buckle position is fastened, you will hear a click tone, indicating that the upper part has cooperated with the buckle position.
- 3:Lift the upper section gently to check whether it is loose from the buckle. If it is loose, please operate again.

b) Instructions before use

Please store this product in a dry place, do not expose the product to direct sunlight. Put the carpet under the product to minimize the working noise.

c) How to use it

This product uses only the 220-240V~, 50-60Hz power supply.

Make sure your indoor voltage fits this specification parameter.

- Connect the AC power cord to the socket.
- Turn on the power switch at the back of product to "I", when the red light is on, the yellow light on control panel blinks, the product is in standby mode.

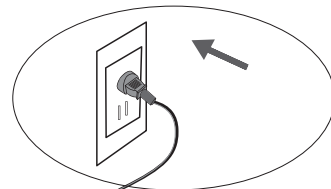

Do not insert or remove the plug with a wet hand



Product Operation Guide

- Place your legs in the product, before pressing the switch key on screen. When the blue light is on, the other functions will follow. According to the indicators on the control panel, you can choose different massage modes.
- When you start the massage, the product will be countdown in 15minutes. After 15 minutes, the massage function is turned off, and it will recover to standby mode.
- When the product is on standby, press the main switch “0” to cut off the power.

Product Maintenance

a) Storage

- Please store it in the packing carton, and put in a safe, dry, well-ventilated, and shaded place.
- Do not twist the power plug.
- Do not hang the power wire and pull the product.
- Avoid sharp items from destroying the surface of the product.
- Please don't store the machine under direct sunlight or in places of high temperature.

b) Clean

- Before cleaning, make sure that the power cord is unplugged from the electrical outlet and that the machine is completely cool.
- Use a damp cloth to clean the product. Ensure the product is completely dry before reuse.
- The detachable fabric cloth can be washed in a normal washing way.

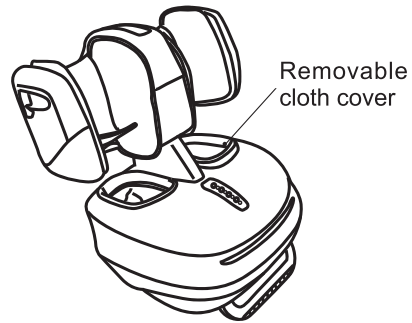

*Attention

- Make sure not to use benzene or thinner and other corrosive detergents to clean the product.

c) Maintenance

- Keep the product clean and store in a dry environment.
- When the product is not in use for a long time, please put a dustproof cover on the product.

Troubleshooting

If you meet the following problems, please referring to the following solutions. If the product is still malfunctioning or doesn't work, please send the product to our service centre or an authorized technician for the necessary checks and repair.

| Conditions | Possible reason | Solutions |
|-----------------------|---|---|
| It doesn't work | <ol style="list-style-type: none">1. Plug isn't connected correctly to the socket.2. There was no power in the upper section3. The panel key is not open | <ol style="list-style-type: none">1. Push the plug firmly into the socket.2. The upper part can only be used after charging3. Open the panel |
| Stop working suddenly | <ol style="list-style-type: none">1. The power switch is off.2. Massage time is over 15 minutes.3. If it is working for a long time, the motor will be protected against overheating.4. If you put heavy pressure on the rollers and the rollers do not work well. | <ol style="list-style-type: none">1. Check that the power plug is connected well.2. Restart the power supply switch.3. After the product is cooled down, please restart the ON/OFF power.4. Switch off the power supply, and turn it on again. |



Product Specifications

| | |
|-----------------------------|---------------------|
| Product name | Omknee2.0 |
| Model number of the product | OF 2004 |
| Voltage | 220-240V~ , 50-60Hz |
| Power consumption | 51W |
| Timer | 15 minutes |



Contact Us

MALAYSIA

Healthy World Lifestyle Sdn Bhd
No. 22 Jalan Anggerik Mokara 31/47
Kota Kemuning, 40460 Shah Alam
Selangor Darul Ehsan, Malaysia
Tel : +603-5121 4286
Fax: +603-5121 4386

SINGAPORE

OGAWA Health-Care Pte Ltd
27/Tampines Industrial Avenue 5,
T5@Tampines
Singapore 528623
Tel: +065-6846 8588
Fax: +065-6846 7677

INDONESIA

PT Healthy World
Lodan Center Block O No 20
Jalan Lodan Raya No 2
Jakarta Utara 14430
Tel : +62 21-6983 1123
Fax: +62 21-6983 1124

HONG KONG,CHINA

OGAWA Health Care International(HK) Ltd
31/F,YHC tower,1Sheung Yuet Road
Kowloon Bay
Kowloon
Hong Kong
Tel:+852 3465 6262
Fax:+852 2410 0119

VIETNAM

OGAWA Vietnam Co Ltd
2nd floor,Petroland Tower,
12 Tan Trao, Tan Phu ward
District 7
Ho Chi Minh
Tel: +848 54133 222/54133 223
Fax: +848 5416 1736

PHILIPPINES

O-Healthcare Solution Phil. Inc.
2303, 4th Floor, G&A Building,
Chino Roces Avenue Extension,
Makati City, Philippines
Tel : +632 889 0676 / + 632 844 6851
Fax: +632 812 0421

目录

| | |
|-----------|----|
| 安全说明 | 18 |
| 保修权限 | 21 |
| 产品部件 | 22 |
| 产品特性及使用示意 | 23 |
| 产品操作说明 | 24 |
| 产品保养 | 28 |
| 疑难解答 | 29 |
| 产品规格 | 30 |
| 联络我们 | 31 |

感谢您购买 OGAWA Omknee 2.0 分离式多功能护膝腿机，使用前请仔细阅读操作手册，并特别注意安全事项，以便正确操作和使用本产品。
本手册提供使用者安全及有效的操作方式，请在阅毕后妥为收藏，以便日后参考查询。

安全说明

a) 重要安全事项说明

- 为确保安全及正确使用产品，使用前请务必详细参阅操作手册。
- 请务必依照本操作手册内的产品用途使用本产品。
- 清洁产品前，请将电源插头从插座中拔除。
- 请务必谨慎使用温热功能，以避免可能会导致严重灼伤。请勿用于感觉迟钝和过于敏感的皮肤。切勿让儿童或者身心功能障碍者自行使用温热功能，操作不当可能存在危险。
- 为避免因过热而导致走火、触电、或造成伤害，请勿将产品置于枕头或毯子下操作。
- 请勿覆盖使用，以免造成马达温度过高而导致故障或损坏。
- 如在按摩进行中感到不适，请立即停止按摩。
- 下列状况发生时，切勿使用本产品：电源线或电源插头损坏；操作不正常；曾倾倒或者损伤；曾浸入水中或其他液体。请联系维修服务中心进行检查和维修。
- 请勿使用非OGAWA所推荐的零配件。
- 请勿将物品插入或者掉落产品的任何开口中。
- 若想切断电源，请将所有的操作控制关闭后，将电源插头从插座中拔除。
- 本产品不能作为自我诊断或治疗之用，如需要诊断或治疗，应由专业医疗人员处理。

b) 使用环境

- 请勿在潮湿或过多灰尘的环境下使用产品，以免产品发生故障。
- 请勿在室温高于40°C的环境下使用本产品。
- 请勿将产品放置户外。
- 请勿将产品置放于电热器、炉具附近或者阳光直射处。

安全说明

c) 操作安全

- 确保本产品远离发热表面及区域。
- 此产品不适宜以下人士使用：
 - 心脏病患者、恶性肿瘤患者、脊椎侧弯或异常、骨质疏松症等。
 - 孕妇或经期女性。
 - 身体不适者，发烧、身体有红肿或发炎、瘀青、过敏等。
 - 医生叮嘱禁止按摩的人请勿使用，以免导致事故或身体不适如血栓（栓塞）病症；重度动脉瘤；急性静脉瘤；各种皮肤炎；皮肤感染病症（含皮下组织炎症）等。
 - 绝对不能与以下医疗电子仪器一起使用
 - 1) 心脏起搏器等植入式医疗电子仪器。
 - 2) 人工心脏等用来维持生命的医疗电子仪器。
 - 3) 心电图机等佩戴式医疗电子仪器。

否则可能会导致上述医疗电子仪器产生误动作，可能会危及生命。

d) 开关注意事项

- 请勿用湿手操作控制开关。
- 请勿让控制开关接触水等液体。

e) 使用电源插头及电源线须知

- 请勿用潮湿的双手安插或者拔除电源插头，以免触电或者导致机件故障。
- 拔出电源插头时，请握住插头本身，切勿拉扯电线。
- 虽然15分钟自动定时功能会自动停止产品运作，仍请每次使用完毕后，务必将主电源切断。
- 电源线务必与加热表面保持安全距离。
- 请勿将电源线置于产品或任何重物之下。
- 请勿将电源线缠绕于产品上，以免电源线受损而导致触电或者电线走火。
- 当电源线或者电源插头损坏时，切勿继续使用产品。
- 电源插座有松动的状况时，请勿使用产品。
- 请勿以拉扯电源线方式移动产品，或将电源线当握把使用。
- 当电源线损坏时，必须由服务中心或经授权技术人员进行检查及维修。

安全说明

注意

- 请勿在产品操作时入睡。
- 请勿在酒醉或身体不适时使用本产品。
- 请勿站在产品上或重物施压。
- 连续使用本产品时间请勿超过三十分钟。
- 若产品的布套已经破损，请勿使用。
- 请勿在进食前后一小时使用，以免造成反效果。
- 在偏低室温中使用产品时，切勿骤然使用温热功能，建议将温度逐渐调至正常范围后再使用。
- 若是将产品由低温储存处移至温暖环境使用时，可能会因为机件内水汽聚集而影响产品正常运作，甚至造成机件故障。建议移动后，先将产品在正常室温放置1小时后再开始使用。
- 使用中察觉任何机件故障或不正常状况，请立即停止使用。
- 若在使用中发生电流中断的状况，因注意避免因电力突然恢复而造成使用者受伤。
- 雷电情形发生时，不宜使用本产品。

保修权限

1. 本保修权限不可转让。
2. 本保修服务仅对在 OGAWA 购买的产品有效。
3. 当要求保修服务时，请出示购买证明（正本收据）。
4. 所有保修项目，包括但不限于这些健身及适销性的保修项目有效期限需视保修政策而定。
5. 因错误使用、处理不当以及未经授权私自改装和维修产品而导致的损坏，不属于保修范围。
6. 此保修范围不包括不属于产品本身的附件。
7. 此保修范围不适用于租赁、交易、商业、机构或其他非住宅用户。
8. 此保修范围内所涉及的维修服务需经过 OGAWA 授权，且必须由授权的技术人员维修。
9. 若需更换的维修附件缺货，OGAWA 有权采用替代配件进行维修。

产品部件

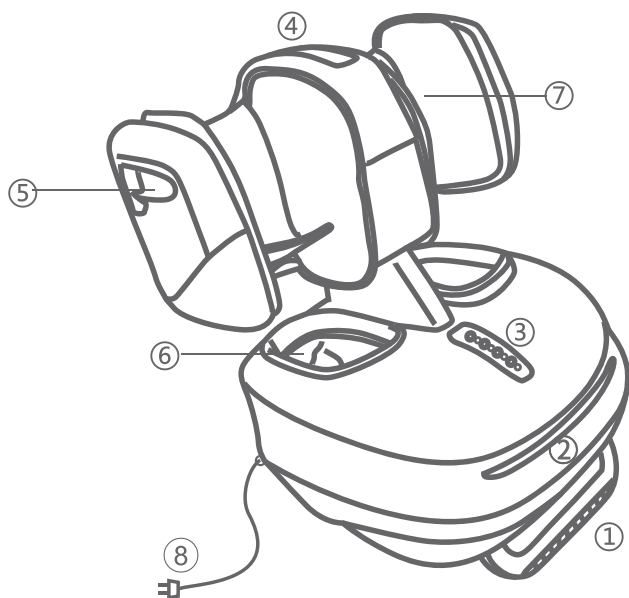

- ① 支架
- ② 装饰条
- ③ 下节控制面板
- ④ 上节控制面板
- ⑤ 分离按键
- ⑥ 下节脚套
- ⑦ 上节布套
- ⑧ 电源线

产品特性及使用示意

1. 享受热敷

*分别在膝腿部和足部配置远红外加热功能，开启加热按键，膝腿部和足部同时加热。可迅速升温至45℃左右。

*加大包覆面积，舒适的温热可促进静脉及微血管的收缩，进一步促进循环和缓解肌肉僵硬紧绷的。

2. 腿部按摩益处

*长期坚持腿部按摩、可加快下肢静脉回流，增加回心血量；缓解压力，可瘦小腿，和小腿肚说拜拜



3.脚背气压的好处

- *脚背气压按摩，促进各反射区，增进血液循环，舒筋活血；使其双脚彻底放松；
- *向下顶压，让脚掌更贴合按摩头，在享受揉顶、刮痧时更舒适到位；

4.气压按摩

- *10组气袋，提供愉悦刺激感，缓和肌肉紧绷酸痛感，为您疲惫双腿立即舒缓。
- *脚后跟部及腿后部增加凸点按摩；更精确刺激按摩点，让按摩更舒适；赶走疲劳；
- *气压按摩同时有效固定足部，让滚揉，刮痧和揉顶的效果更佳到位，深入。

5.脚底按摩

- *脚底三组揉捏按摩头，犹如专业脚底按摩技法，反射区滚轮按摩专门刺激足底重要穴位。
- *三组各不同按摩凸点，带来不同的按摩感受，享受搓揉、刮顶、滚揉的按摩效果；
- *定点按摩，准确按摩涌泉穴，按摩更深入。

产品使用示意

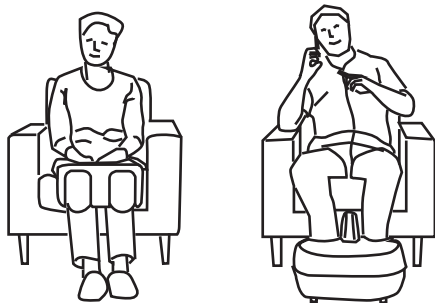
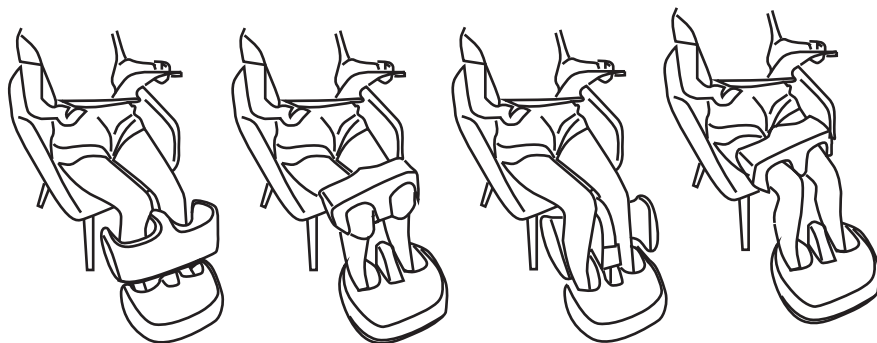

产品操作说明

上节操作面板在合体后做为整体操作面板使用,下节操作面板不可操作使用。
分体后上节和下节的控制面板都可单独操作使用。

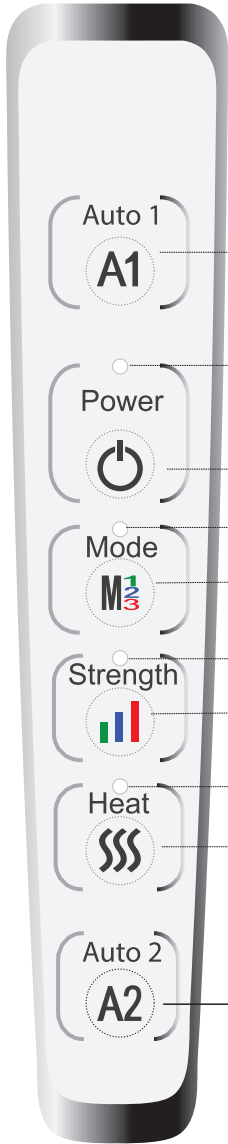

1.按下"开关"按键后.按下"腿智动",开启腿部模式,模式绿灯亮:连体时候上下联动,分体时,只启动腿部功能。

2.电池电量低于50%以下红灯亮,高于50%绿灯亮.充电时红灯慢闪。
充满后(90%)绿灯亮.按开关键,绿灯亮,进入待机.10分钟后无按键操作,进入节能模式.再按一次关机.{任何功能情况下,按开关后关机进入节能模式}

3.开机后按模式一下,模式灯亮,绿灯亮为模式1,蓝灯亮为模式2,红灯亮为模式3.

4.打开模式后,力度灯亮,绿灯为弱档力度,蓝灯为中档力度,红灯为高档力度,一直循环,不开启模式时,按力度键无效。

5.开机后按热敷一下,红灯亮(加热打开):再按一下热敷红灯灭(加热关闭):
打开任何一种模式,加热会跟随启动.(按一下热敷可以关闭加热)

6.按下"开关"按键后.按下"膝智动",开启膝部模式{合体时候,上下功能联动,分体时只启动腿部功能} 模式蓝灯亮

产品操作说明

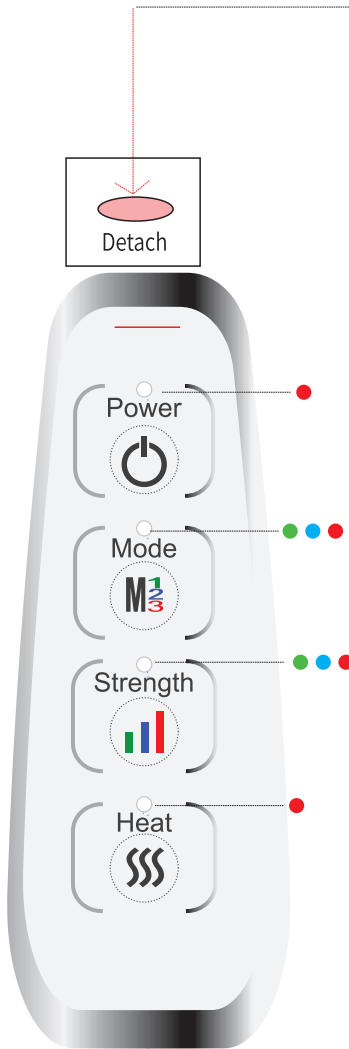

Detach 分离键

(上节左右提手处各设有分离键,按任意一键都可操作)

- 1.分离键在关闭程序后,在待机状态下方可使用
- 2.合体状态下按此键,按键按下放开后6秒内上下节分离,持续按住分离键,可一直保持分离状态
- 3.按分离键产生分离动作后,上下两部分均进入待机状态,此时再按'Detach'(不需要先按开关键),启动腿部自动模式1,模式红灯亮
- 4.将上节接入下节后,下节指示灯熄灭,被上节操作面板接管按键操作功能

下节操作面板只在分离状态下方可操作使用。

- 1.按开关键,红灯亮,进入开机。
再按一次关机.{任何功能情况下,按开后关机}
- 2.开机后按模式一下,模式灯亮,绿灯亮为模式1,蓝灯亮为模式2,红灯亮为模式3.
- 3.打开模式后,力度灯亮,绿灯为弱档力度,蓝灯为中档力度,红灯为高档力度,一直循环,不开启模式时,按力度键无效。
- 4.开机后按热敷一下,红灯亮(加热打开);再按一下热敷红灯灭(加热关闭):
打开任何一种模式,加热会跟随启动.(按一下热敷可以关闭加热)

操作注意事项:

- 1.合体状态下,下节处于通电状态,上节控制板的电源灯亮绿灯
- 2.合体状态下,下节处于断电状态下,上节电池电量高于设定值时,上节控制板的电源灯为绿灯闪烁;电池电量低于设定值时,上节控制板的电源灯为红灯闪烁,则需要下节接通电源充电。
- 3.分离状态下,上节处于开机状态,电池电量高于设定值时,上节控制板的电源灯为绿灯常亮,电池电量低于设定值时,上节控制板的电源灯为红灯常亮,
- 4.分离状态下,上节处于没电状态,上节控制板的电源灯不亮,需要上下节合体后,下节接通电源充电。

产品操作说明

扣紧说明:

上下合体时,需要以下步骤确保上下节合体是否到位

- 1.上节部分扣到下节扣位时,上节感应灯亮绿灯,并发出提示声音
- 2.上下扣位在扣紧时会嗒一声,确保上节部分已经与扣位配合
- 3.用手轻提上节部分是否会从扣位松脱,如松脱,请重新操作。

a) 使用前准备

请将本产品置于干燥、阳光不能长期照射的地方。

为减少机器工作时的噪音,可在本产品下铺上地毯。

确保产品放置位置安稳舒适。

b) 使用方法

本产品仅使用于 220 - 240V~, 50-60Hz 的电源。请事先检查您家中电压是否与本产品上所示规格相符。

- 将交流电源插头接至电源插座。
- 此时控制面板上下开关键红灯闪烁,产品进行待机状态。

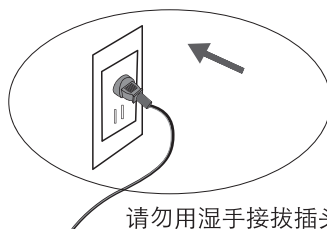

请勿用湿手接拔插头



产品操作说明

- 将双脚放入产品，按下控制面板开关键，绿灯指示;其它按键功能响应。依控制面板指示，选择按摩模式。
- 使用产品倒计时15分钟结束后，按摩功能停止，恢复待机状态。
- 产品处于待机状态时，电源切断。

产品保养

a) 贮藏

- 不使用时，请将产品放入包装盒中，并放置于安全、干燥、通风、阴凉处。
- 切勿拧曲电源线。
- 切勿使用电源线拖拽产品。
- 避免尖状物刮破产品表面。
- 请勿将产品放置在阳光直射或高温处。

b) 清洁

- 清洁之前，确认总电源开关已关闭，并拔出电源插头。
- 请使用干布清洁产品表面。
- 可拆洗布套可按正常布料洗涤方式清洗。

*注意

- 切勿使用具有腐蚀性的清洁剂，如苯或稀释剂来清洁产品。



c) 保养

- 保持产品清洁并远离高湿度的场所。
- 如果长时间不使用本产品，请用防尘罩(请自行购买)套住产品，防止落入灰尘。

疑难解答

若在使用此产品时遇到问题，请参考下列几点提示及可能解决方式。若此产品仍处于故障状态请将产品送至服务中心或经授权技术人员进行检查及维修。

| 故障 | 原因 | 处理方法 |
|---------|--|---|
| 无法开机。 | <ol style="list-style-type: none">1. 未通电2. 上节部分没电3. 面板开关键未开启 | <ol style="list-style-type: none">1. 接入电源或检查否连接良好2. 上节部分需要充电后方可使用3. 开启面板开关键 |
| 突然停止操作。 | <ol style="list-style-type: none">1. 断电。2. 按摩时间超过15分钟。3. 连续使用时间过长，产品过热保护。4. 施力过大，按摩球堵转。 | <ol style="list-style-type: none">1. 检查电源接口是否接好。2. 重新开启开关键。3. 产品冷却后重新开启开关键。4. 重新启动开关键。 |

产品规格

| | |
|------|---------------------|
| 产品名称 | Onknee 2.0 |
| 产品型号 | OF 2004 |
| 电压 | 220V-240V~, 50-60Hz |
| 功率 | 51W |
| 定时 | 15 分钟 |

联络我们

马来西亚

Healthy World Lifestyle Sdn Bhd
No. 22 Jalan Anggerik Mokara 31/47
Kota Kemuning, 40460 Shah Alam
Selangor Darul Ehsan, Malaysia
Tel: +603-5121 4286
Fax: +603-5121 4386

新加坡

OGAWA Health-Care Pte Ltd
27/Tampines Industrial Avenue 5,
T5@Tampines
Singapore 528623
Tel: +065-6846 8588
Fax: +065-6846 7677

印尼

PT Healthy World
Lodan Center Block O No 20
Jalan Lodan Raya No 2
Jakarta Utara 14430
Tel: +62 21-6983 1123
Fax: +62 21-6983 1124

中国香港

OGAWA Health Care International(HK) Ltd
31/F,YHC tower,1Sheung Yuet Road
Kowloon Bay
Kowloon
Hong Kong
Tel:+852 3465 6262
Fax:+852 2410 0119

越南

OGAWA Vietnam Co Ltd
2nd floor,Petroland Tower,
12 Tan Trao, Tan Phu ward
District 7
Ho Chi Minh
Tel: +848 54133 222/54133 223
Fax: +848 5416 1736



菲律宾

O-Healthcare Solution Phil. Inc.
2303, 4th Floor, G&A Building,
Chino Roces Avenue Extension,
Makati City, Philippines
Tel : +632 889 0676 / +632 844 6851
Fax: +632 812 0421



目錄

| | |
|-----------|----|
| 安全說明 | 33 |
| 保修權限 | 36 |
| 產品部件 | 37 |
| 產品特性及使用示意 | 38 |
| 產品操作說明 | 39 |
| 產品保養 | 43 |
| 疑難解答 | 44 |
| 產品規格 | 45 |
| 聯絡我們 | 46 |



感謝您購買OGAWA Omknee 2.0 分離式多功能護膝腿機，使用前請仔細閱讀操作手冊，並特別注意安全事項，以便正確操作和使用本產品。
本手冊提供使用者安全及有效的操作方式，請再閱畢後妥為收藏，以便日後參考查詢。

安全說明

a)重要安全事項說明

- 為確保安全及正確使用產品，使用前請務必詳細參閱操作手冊。
- 請務必依照本操作手冊內的產品用途使用本產品。
- 清潔產品前，請將電源插頭從插座中拔除。
- 請務必謹慎使用溫熱功能，以避免可能會導致嚴重灼傷。請勿用於感覺遲鈍和過於敏感的皮膚。切勿讓兒童或者身心功能障礙者自行使用溫熱功能，操作不當可能存在危險。
- 為避免因過熱而導致走火，觸電，或造成傷害，請勿將產品置於枕頭或毯子下操作。
- 請勿覆蓋使用，以免造成馬達溫度過高而導致故障或損壞。
- 如在按摩進行中感到不適，請立即停止按摩。
- 下列狀況發生時，切勿使用本產品：電源線或電源插頭損壞；操作不正常；曾傾倒或損傷；曾浸入水中或其它液體。請聯繫維修服務中心進行檢查和維修。
- 請勿使用非OGAWA所推薦的零配件。
- 請勿將物品插入或者掉落產品的任何開口中
- 若想切斷電源，請將所有的操作控制關閉後，將電源插頭從插座中拔除。
- 本產品不能作為自我診斷或者治療之用，如需要診斷或者治療，應由專業的醫療人員處理。

b)使用環境

- 請勿在潮濕或者過多灰塵的環境下使用產品，以免發生故障。
- 請勿在室溫高於40°C的環境下使用本產品。
- 請勿將產品放置戶外。
- 請勿將產品置放於電熱器，爐具附近或者陽光直射處。

安全說明

c) 操作安全

- 確保本產品遠離發熱表面及區域。
- 此產品不適宜以下人士使用：
 - 心臟病患者，惡性腫瘤患者，脊椎側彎或異常，骨質疏鬆症等。
 - 孕婦或經期女性。
 - 身體不適者，發燒，身體有紅腫或發炎，淤青，過敏等。
 - 醫生叮囑禁止使用按摩的人請勿使用，以免導致事故或者身體不適如血栓（栓塞）病症，重度動脈瘤，急性靜脈瘤，各種皮膚炎，皮膚感染病症（含皮下組織炎症）等。
 - 絕對不能與以下醫療電子儀器一起使用
 - 1) 心臟起搏器等植入式醫療電子儀器。
 - 2) 人工心臟等用來維持生命的醫療電子儀器。
 - 3) 心電圖機等佩戴式醫療電子儀器。否則可能會導致上述電子儀器產生誤動作，可能會危及生命。

d) 開關注意事項

- 請勿用濕手操作控制開關。
- 請勿讓控制開關接觸水等液體。

e) 使用電源插頭及電源線須知

- 請勿用潮濕的雙手安插或者拔除電源插頭，以免觸電或者導致機件故障。
- 拔出電源插頭時，請握住插頭本身，請勿拉扯電線。
- 雖然15分鐘自動定時功能會自動停止產品運作，仍請每次使用完畢後，務必將主電源切斷。
- 電源線務必與加熱表面保持安全距離。
- 請勿將電源線置於產品或任何重物之下。
- 請勿將電源線纏繞於產品上，以免電源線受損爾導致觸電或電線走火。
- 當電源線或電源插頭有損壞時，切勿繼續使用產品。
- 請勿以拉扯電源線的方式移動產品，或將電源線當握把使用。
- 當電源線損壞時，必須由服務中心或經授權技術人員進行檢查及維修。

安全說明

注意

- 請勿在產品操作時入睡。
- 請勿在醉酒或者身體不適時使用本產品。
- 請勿站在產品上或者重物施壓。
- 請勿連續使用本產品超過30分鐘。
- 若產品的布套已經破損，請勿使用。
- 請勿在進食前後一小時使用，以免造成反效果。
- 在偏低室溫使用產品時，切勿驟然使用溫熱功能，建議將溫度逐漸調至正常範圍後再使用。
- 若是將產品由低溫儲存處移到溫暖環境中使用時，可能會因為機件內水氣聚集爾影響產品正常運作，甚至造成機器故障。建議移動後，先在正常室溫放置1小時後再開機使用。
- 使用中如察覺任何機件故障或不正常狀況，請立即停止使用。
- 若在使用中發生電流中斷的狀況，應注意避免因電力突然恢復爾造成使用者受傷。
- 雷電情形發生時，不宜使用本產品。



保修權限

1. 本保修權限不可轉讓。
2. 本保修服務僅對在OGAWA購買的產品有效。
3. 當要求保修服務時，請出示購買證明（正本收據）。
4. 所有保修項目，包括但不限於這些健身及試銷性的保修項目有效期限需視保修政策而定。
5. 因錯誤使用，處理不當以及未經授權私自改裝和維修產品而導致的損壞，不屬於保修範圍。
6. 此保修範圍不包括不屬於產品本身的附件。
7. 此保修範圍不適用於租賃，交易，商業，機構或其他非住宅用戶。
8. 此保修範圍內設計的維修服務需經過OGAWA 授權，且必須由授權的技術人員維修。
9. 若需更換的維修附件缺貨，OGAWA 有權採用替代配件進行維修。

產品部件

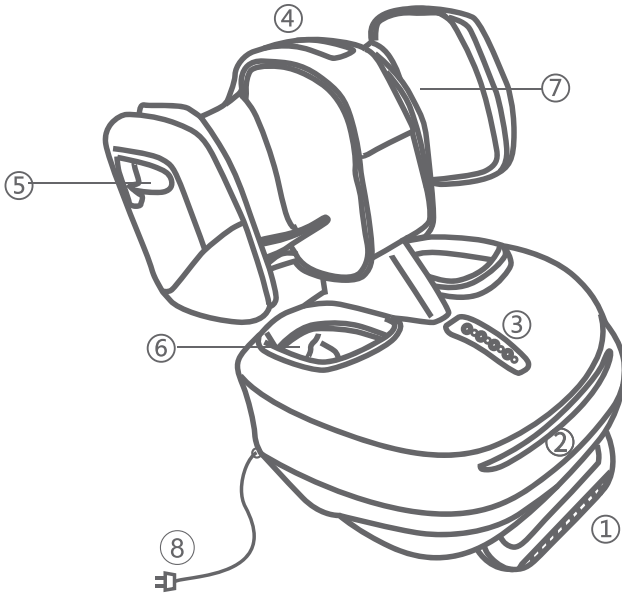

- ① 支架
- ② 裝飾條
- ③ 下節控制面板
- ④ 上節控制面板
- ⑤ 分離按鍵
- ⑥ 下節腳套
- ⑦ 上節布套
- ⑧ 電源線

產品特性及使用示意

1. 享受熱敷

*分別在膝腿部和足部配置遠紅外加熱功能，開啟加熱按鍵，膝腿部和足部同時加熱。可迅速升溫至45°C左右。

*加大包覆面積，舒適的溫熱可促進靜脈及微血管的收縮，進一步促進循環和緩解肌肉僵硬緊繃。

2. 腿部按摩益處

*長期堅持腿部按摩，可加快下肢靜脈回流，增加回心血量；緩解壓力，可瘦小腿，和小腿肚說拜拜

3.腳背氣壓的好處

- *腳背氣壓按摩，促進各反射區，增進血液循環，舒經活血，使雙腳徹底放鬆；
- *向下頂壓，讓腳掌更貼合按摩頭，在享受揉頂，刮痧時更舒適到位。

4.氣壓按摩

- *10組氣袋，提供愉悅刺激感，緩和肌肉緊繃酸痛感，讓您疲憊的雙腿得到舒緩。
- *腳後跟部及腿後部增加凸點按摩，更精確刺激按摩點，讓按摩更舒適，趕走疲勞；
- *氣壓按摩同時有效固定足部，讓滾揉，刮痧和揉頂的效果更加到位，深入。

5.腳底按摩

- *腳底三組揉捏按摩頭，猶如專業腳底按摩技法，反射區滾輪按摩專門刺激足底重要穴位，
- *三組各不同按摩凸點，帶來不同的按摩感受，享受搓揉，刮頂，滾揉的按摩效果；
- *定點按摩，準確按摩湧泉穴，按摩更深入。

產品使用示意

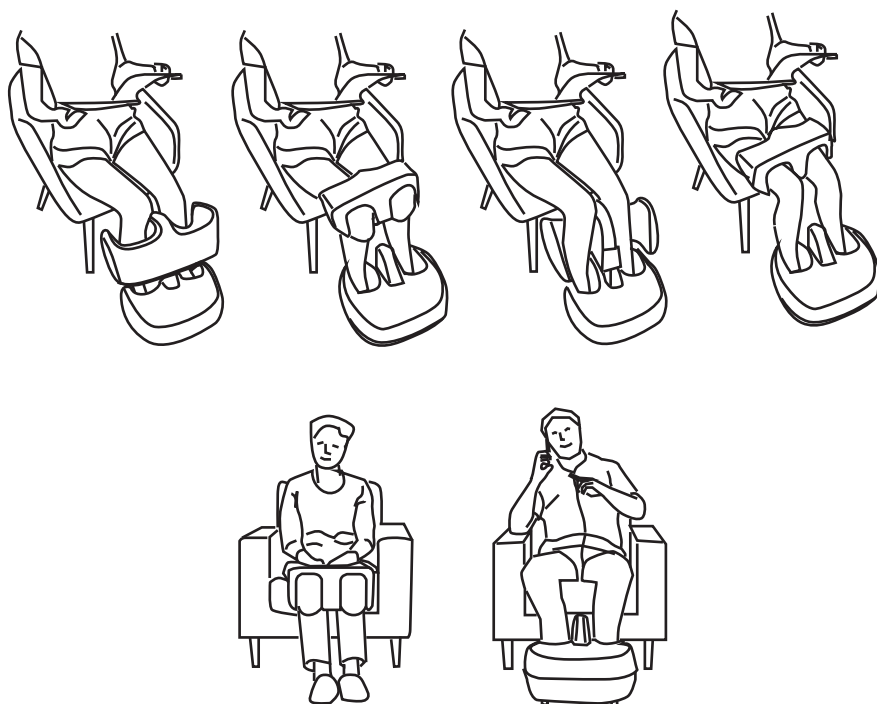

產品操作說明

上節操作面板在合體後做為整體操作面板使用，下節操作面板不可操作使用。

分體後上節和下節的控制面板都可單獨操作使用。

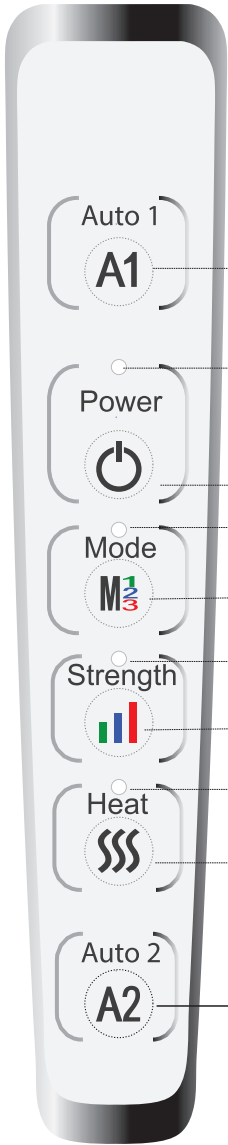

1. 按下"POWER"按鍵後. 按下"AUTO",開啓腿部模式,模式綠燈亮:
連體時候上下聯動分體時只啓動腿部。
2. 電池電量低於50%以下紅燈亮,高於50%綠燈亮,充電時紅燈慢閃。
充飽後(90%)綠燈亮.按"POWER",綠燈亮,進入待機。10分鐘後無按鍵
操作,進入節能模式.再按一次關機。{任何功能情況下,按開關後關機進入
節能模式}
3. 開機後按Mode一下, Mode燈亮,綠燈為Mode1,藍燈為Mode2,紅燈為Mode3。
4. 打開Mode後, "Strength"燈亮,綠燈為弱檔力度,藍燈為中檔力度,紅燈為高檔
力度;一直循環。不開啟MODE時候,按"Strength"無效。
5. 開機後按"HEAT"一下,紅燈亮(加熱打開):再按一下"HEAT"紅燈滅(加熱
關閉):打開任何一種模式,加熱會跟隨啓動。(按一下"HEAT"可以關閉加熱)。
6. 按下"POWER"按鍵後. 按下"QUICK",開啓膝部模式{合體時候,
上下功能聯動,分體時只啓動腿部功能} 模式藍燈亮。

產品操作說明

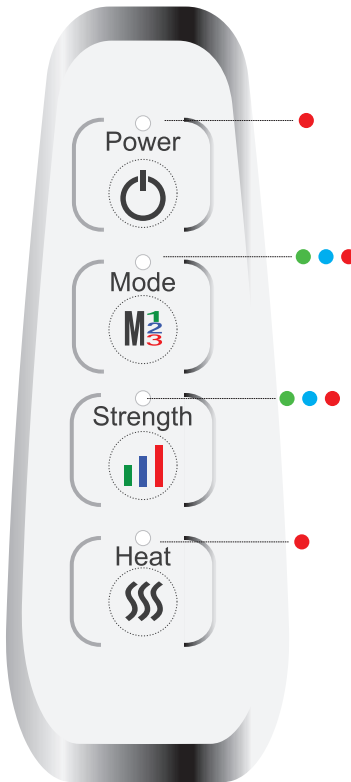
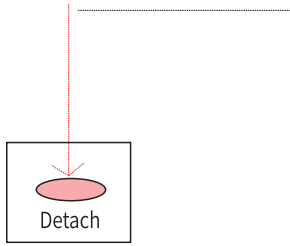

Detach 分離鍵

(上節左右提手處各設有分離鍵,按任意一鍵都可操作)

1. 分離鍵在關閉程序後,在待機狀態下方可使用
2. 合體狀態下按此鍵,按鍵按下放開後6秒內上下節分離,持續按住分離鍵,可一直保持分離狀態
3. 按分離鍵產生分離動作後,上下兩部分均進入待機狀態,此時再按'Detach'(不需要先按開關鍵),啓動腿部自動模式1,模式紅燈亮
4. 將上節接入下節後,下節指示燈熄滅,被上節操作面板接管按鍵操作功能

下節操作面板只在分離狀態下方可操作使用。

1. 按"POWER"鍵,紅燈亮,進入開機。
再按一次關機。{任何功能情況下,按"POWER"後關機}
2. 開機後按Mode一下,Mode燈亮,綠燈為Mode1,藍燈為Mode2,紅燈為Mode3。
3. 打開Mode後,"Strength"燈亮,綠燈為弱檔力度,藍燈為中檔力度,紅燈為高檔力度;一直循環。不開啟MODE時候,按"Strength"無效。
4. 開機後按"HEAT"一下,紅燈亮(加熱打開);再按一下"HEAT"紅燈滅(加熱關閉):
打開任何一種模式,加熱會跟隨啓動。(按一下"HEAT"可以關閉加熱)

操作注意事項:

1. 合體狀態下,下節處於通電狀態,上節控制板的電源燈亮綠燈
2. 合體狀態下,下節處於斷電狀態下,上節電池電量高於設定值時,上節控制板的電源燈為綠燈閃爍;電池電量低於設定值時,上節控制板的電源燈為紅燈閃爍,則需要下節接通電源充電。
3. 分離狀態下,上節處於開機狀態,電池電量高於設定值時,上節控制板的電源燈為綠燈常亮,電池電量低於設定值時,上節控制板的電源燈為紅燈常亮,
4. 分離狀態下,上節處於沒電狀態,上節控制板的電源燈不亮,需要上下節合體後,下節接通電源充電。

產品操作說明

扣緊說明：

上下合體時，需要以下步驟確保上下節合體是否到位

1. 上節部分扣到下節扣位時，上節感應燈亮綠燈，並發出提示聲音
2. 上下扣位在扣緊時會嗒一聲，確保上節部分已經與扣位配合
3. 用手輕提上節部分是否會從扣位鬆脫，如鬆脫，請重新操作。

a) 使用前準備

請將本產品置於乾燥，陽光不能長期照射的地方。

為減少機器工作時的噪音，可在本產品下鋪上地毯。

確保產品放置的位置安全舒適。

b) 使用方法

本產品僅使用220-240V~，50-60Hz的電源。請事先檢查您家中電壓是否與本產品上所示的規格相符。

- 將交流電源插頭接至電源插座。
- 此時控制面板上下開關鍵紅燈閃爍產品進行待機。

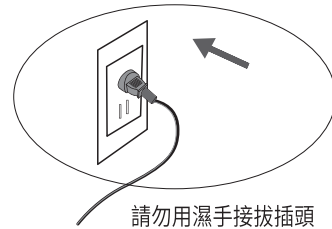



產品操作說明

- 將雙腳放入產品，按下控制面板開關鍵，綠燈指示；其他功能響應。依控制面板指示，選擇按摩模式。
- 使用產品倒計時15分鐘結束後，按摩功能停止，恢復待機狀態。
- 產品處於待機狀態時，請切斷電源。

產品保養

a) 貯藏

- 不使用時，請將產品放入包裝盒中，並放置於安全，乾燥，通風，陰涼處。
- 切勿擰曲電源線。
- 切勿使用電源線拖拽產品。
- 避免尖銳物刮破產品表面。
- 請勿將產品放置在陽光直射或高溫處。

b) 清潔

- 清潔之前確認總電源開關已關閉，並拔出電源插頭。
- 請使用乾布清潔產品表面。
- 可拆洗布套可按正常布料清潔方式清洗。

*注意

- 切勿使用具有腐蝕性的清潔劑，如笨或稀釋劑來清潔產品。



c) 保養

- 保持產品清潔並遠離高濕度的場所。
- 如長期不使用本產品，請用防塵罩(需自行購買)套住產品，防止落入灰塵。

疑難解答

若在使用本產品時遇到問題，請參考下列幾點提示及可能的解決方式。若此產品仍處於故障狀態請將產品送至服務中心或經授權技術人員進行檢查及維修。

| 故障 | 原因 | 處理方法 |
|--------|--|---|
| 無法開機 | <ol style="list-style-type: none">1.未通電2.上節部分沒電3.面板開關鍵未開啟 | <ol style="list-style-type: none">1.接入電源或檢查是否連接好2.上節部分需要充電後方可使用3.開啟面板開關鍵 |
| 突然停止操作 | <ol style="list-style-type: none">1.斷電2.按摩時間超過15分鐘3.連續使用時間過長，產生產品過熱保護4.施力過大，按摩球堵轉 | <ol style="list-style-type: none">1.檢查電源接口是否接好2.重新開啟開關鍵3.產品冷卻後重新開啟開關鍵4.重新啟動開關鍵 |



產品規格

| 產品規格 | Onknee 2.0 |
|------|---------------------|
| 產品名稱 | OF 2004 |
| 電壓 | 220V-240V~, 50-60Hz |
| 功率 | 51W |
| 定時 | 15分鐘 |



聯絡我們

馬來西亞

Healthy World Lifestyle Sdn Bhd
No. 22 Jalan Anggerik Mokara 31/47
Kota Kemuning, 40460 Shah Alam
Selangor Darul Ehsan, Malaysia
Tel: +603-5121 4286
Fax: +603-5121 4386

新加坡

OGAWA Health-Care Pte Ltd
27/Tampines Industrial Avenue 5,
T5@Tampines
Singapore 528623
Tel: +065-6846 8588
Fax: +065-6846 7677

印尼

PT Healthy World
Lodan Center Block O No 20
Jalan Lodan Raya No 2
Jakarta Utara 14430
Tel: +62 21-6983 1123
Fax: +62 21-6983 1124

中國香港

OGAWA Health Care International(HK) Ltd
31/F,YHC tower,1Sheung Yuet Road
Kowloon Bay
Kowloon
Hong Kong
Tel:+852 3465 6262
Fax:+852 2410 0119

越南

OGAWA Vietnam Co Ltd
2nd floor,Petroland Tower,
12 Tan Trao, Tan Phu ward
District 7
Ho Chi Minh
Tel: +848 54133 222/54133 223
Fax: +848 5416 1736

菲律賓

O-Healthcare Solution Phil.Inc.
2303, 4th Floor,G&A Building,
Chino Roces Avenue Extension,
Makati City,Philippines
Tel : +632 889 0676 / + 632 844 6851
Fax: +632 812 0421



Ogawa is grateful
to have received
these awards:



PUTRA
BRAND AWARDS 2010
SILVER
1000th Anniversary of the
Malay Peninsula

Ogawa Wellness Hubs : Malaysia . Singapore . Vietnam . Philippines . Indonesia . Myanmar . India . China
Hong Kong . TaiWan . Turkey . Pakistan . Mauritius . Russia . France . Canada
Thailand . Korea . Australia . Dubai . K.S.A . Nigeria . Egypt . Lebanon . Denmark
Sweden . U.S.A

